

SPECIFICATION

Product Name: ON/OFF Sensor for Tri-proof Light

Issue Date: April 30, 2020

CUSTOMER APPROVED

PRODUCT DIRECTOR APPROVED	SALES CHECKED	R&D CHECKED	PREPARED
邵小东	邵小东	邵小东	邵小东

1. Features

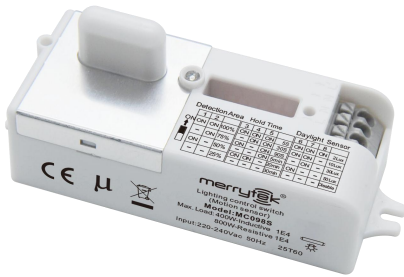

- Ultra-slim design for Tri-proof LED light
- Patented antenna design makes reliable detecting, avoid missing triggered when sensor built-in backside of metal LED plate.
- Adjustable detecting sensitivity via DIP switches, suitable to variety of installation sites.
- Support 6m Max. Mounting height .
- 5 years warranty

2. Parameter

Input	Operating Voltage Range	198-264V AC, 50Hz/60Hz
	Rated Voltage	220-240V AC, 50Hz/60Hz
	Stand-by Power	≤0.5W
	Surge Test	L--N: 1kV
Output	Working Mode	ON/OFF function
	Type of Load	Inductive or Resistive
	Load Capacity	400W(Inductive) ; 800W(Resistive)
	Max. Surge Capacity	30A (50% I _{peak} , t _{width} =500uS, 230Vac full load, cold start); 60A (50% I _{peak} , t _{width} =200uS, 230Vac, full load, cold start)
Sensor Parameters	Operating Frequency	5.8 GHz ±75 MHz , ISM Band.
	Transmitting power	0.5mW Max.
	Hold time	5s//30s/90s/5min/20min/30min
	Detection Sensitivity	100%/75%/50%/25%
	Daylight Sensor	2Lux/10Lux/30Lux/50Lux/Disable
	Detecting Radius	3-10m (mounting height 3-4m) 2-8m(mounting height 6m)
	Mounting Height	6m Max.
	Detecting Angle	150° (Wall mounted), 360° (Ceiling mounted)
Operating Environment	Operating Temperature	-25°C...+60°C
	Storage Temperature	-40°C...+80°C(Humidity: 10%-95% Non-condensing)
Certificate Standards	Safety standards	EN61058-1
	EMC standards	EN300440; EN301489-1; EN55015; EN61547; EN61000-3-2; EN61000-3-3; EN62479
	Environmental Requirement	Compliant to RoHS
	Certificate	CE, RED

Others	Wiring	Press-in Type Terminals, wire diameter : 0.75-1.5mm ²
	IP Rating	IP20
	Protection Class	Class II
	Installation	Built-in
	Dimension	77.5*34.5*22mm
	Package	Bubble bag+Clapboard + Carton (K=A)
	Net Weight	58±2g
	Lifetime	5 years warranty @Ta 230V full load

Note

1. "N/A" means not available.
2. Detection area is effected on volume of motion object and motion speed. The detection area is tested by a 170cm height person and walking speed is 0.3m/s.

3. Function

On/OFF Function

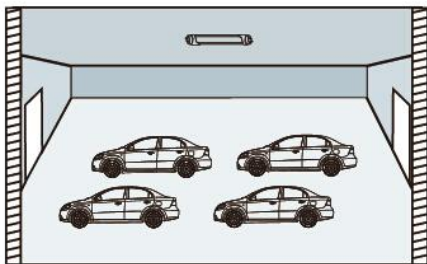

1 With sufficient ambient light, the light will not be switched on even if with motion signal.

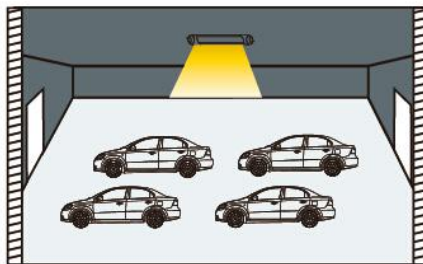

2 With insufficient ambient light, the sensor switches on the light when motion is detected.



3 After elapse of hold time, the sensor switches off the light when no motion is detected.

4. Dimension (mm)

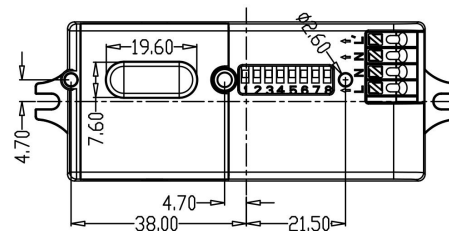
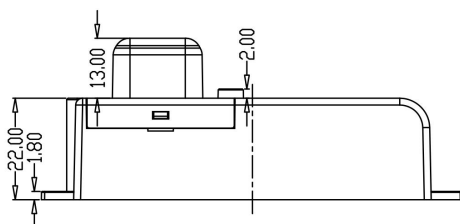
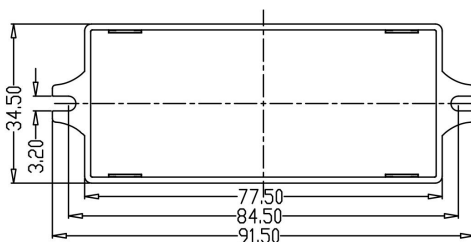

5. Wiring

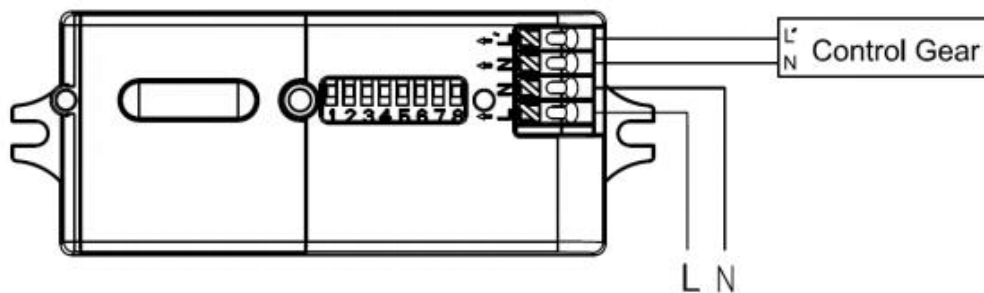

*The sensor is designed for connect one load only. Connect more than one loads may damage the sensor.

6. Structure

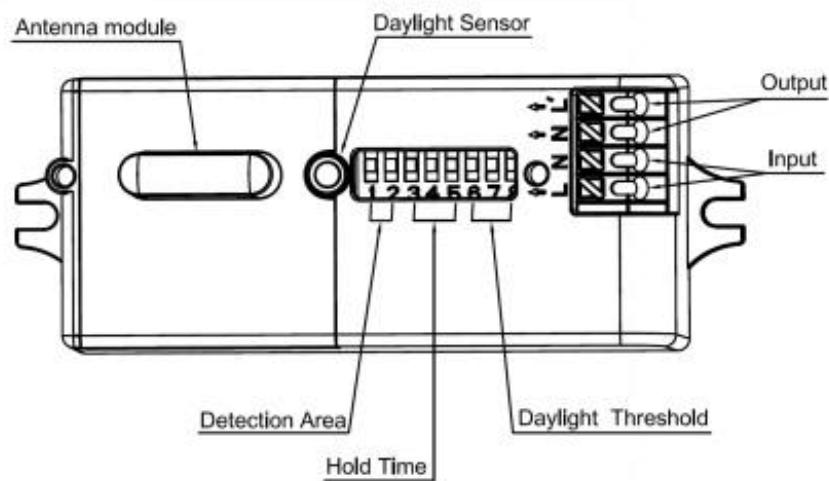

7. Radiation Pattern

1) Ceiling mounting

Ceiling mounted height: 3m
Sensitivity: 100%/75%/50%/25%

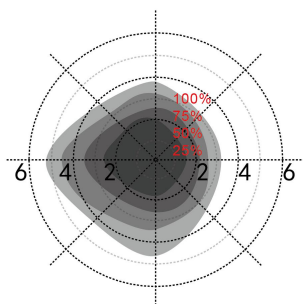

Normal moving (Speed:1m/s)

Ceiling mounted height: 6m(*)
Sensitivity:100%/75%

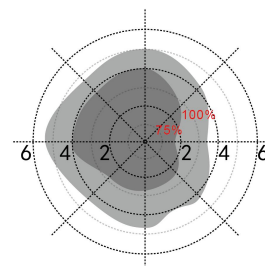

Normal moving (Speed:1m/s)

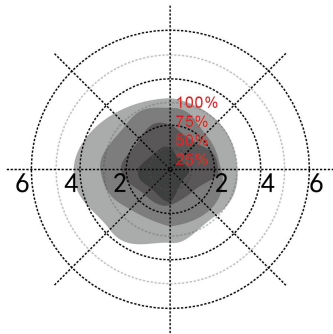

Slow moving (Speed 0.3m/s)

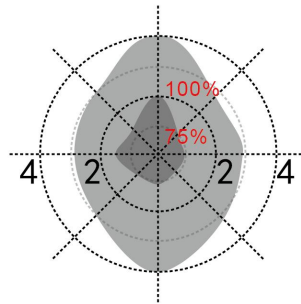

Slow moving (Speed: 0.3m/s)

*Only 100%/75% detection sensitivity is workable when installed at 6m mounting height. 25%/50% sensitivity is not able to detect motion signal.

2) Wall mounting

Horizon mounted height: 2m
Sensitivity: 100%

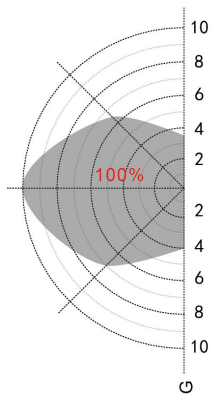

Normal moving (Speed: 1m/s)

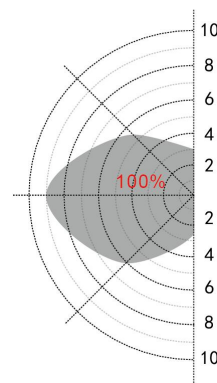

Slow moving (Speed 0.3m/s)

8. DIP Switch Setting

Detection Area (Sensitivity)

	1	2
100%	ON	ON
75%	-	ON
50%	ON	-
25%	-	-

Hold Time

	3	4	5	
I	ON	ON	ON	5S
II	-	ON	ON	30S
III	ON	-	ON	90S
IV	-	-	ON	5min
V	ON	ON	-	20min
VI	-	-	-	30min

Daylight Threshold

	6	7	8	
I	ON	ON	ON	2Lux
II	ON	ON	-	10Lux
III	-	ON	-	30Lux
IV	ON	-	-	50Lux
V	-	-	-	Disable*

*Disable” means the daylight sensor not work. it will turn on light once motion is detected regardless of ambient light .

9. Override Function

Quick switch ON/OFF 3 times within 2sec to override sensor function. Lights will switch on all the time. Power off and on again to recover sensor function.

10. Initialization

After power on, the sensor automatically turns on light at 100% brightness. After 10sec, it turns off the light. During the initialization, the sensor is not able to detect movement.

11. Factory Setting

Detection area: 100%, Hold Time: 5S, Daylight Sensor: Disable

12. Application Notice

- 1) The sensor should be installed by a professional electrician. Please turn off the power before installing, wiring, changing the setting of the DIP switch.
- 2) The sensor which installed in the plastic and glass lampshade will reduce the sensitivity. For every 3mm increase in thickness, the sensitivity will be reduced by 20%.
- 3) The light sensitivity threshold is in a sunny environment, no shadow and ambient light diffuse reflection. Ambient lux level will be different in different environment, weather, climate, time-of-day and season.
- 4) The parameters of the sensor may need to be reconfigured in different installation environments.
- 5) This sensor is for indoor use only. It will affect the waterproof effect for outdoor use. Wind, rain, and moving objects around will cause false triggering.
- 6) The distance between any inductive sensors should be greater than 3m.
- 7) Do not place the sensor close to high-density objects such as metal, glass, concrete walls, etc, false triggering could happen. When the sensor is installed in a metal lamp, metal reflective surface, or a narrow enclosed environment, the microwave will be reflected repeatedly and cause false triggering. Please reduce the sensitivity or contact the manufacturer for technical support.
- 8) Please ensure that there are no moving signals around the sensor, such as fan, DC motor, sewer pipe, air outlet, etc., the sensor may generate false trigger.
- 9) You are advised to test 5 samples before mass application of sensor in a new lighting project.
- 10) Due to continuous improvement, the contents of this instruction could be changed without prior notice.
- 11) If the sensor is built under metal board, make sure the sensor surface should be seamless close to the metal plate without space.

